



HOUSING



TECNIPLAST OFFERS A
RANGE OF SOLUTIONS FOR
BREEDERS THAT MEETS THE
NEW GUIDELINES

Since January 1st, 2017 the new guidelines about Breeding and Stock at Breeders will come into force.

Tecniplast has developed some specific Housing Breeding Systems for small rodents and rabbits to give customers solutions compliant with the new international standards.

11 rows high (and above) to achieve the highest density, the racks are completely configurable in terms of watering solutions, number of rows and columns and layout. Cages are available in a wide range of plastic materials: Polycarbonate, Polysulfone and Polyphenylsulfone.



MICE

■ MICE BREEDING TWIN CAGE

A cage composed by two halves that dramatically cuts down up to 50% running costs: handling one, you actually manage two cages.

■ DUAL BREEDING STOCK RACK

A rack designed for the maximum flexibility: cage slots can be used either for the Twin Cage or the Stock Cage, according to the changing market requests.

Revolutionary
Twin
Concept



MICE



Breeding & Stock Cages in the same Rack!

Cage	Floor Area (cm ² /in ²)	Internal Height (mm/in)	Overall Dimensions (mm/in)
MICE BREEDING TWIN CAGE	339.70 / 52.65	120 / 4.72	420x332x126 / 16.53x13.07x4.96
MICE STOCK CAGE	960.00 / 148.80	120 / 4.72	450x332x126 / 17.72x13.07x4.96



MICE BREEDING TWIN CAGE



MICE STOCK CAGE



RATS



Cage	Floor Area (cm ² /in ²)	Internal Height (mm/in)	Overall Dimensions (mm/in)
1500 BREEDING+STOCK CAGE	1535.50 / 238.00	180 / 7.09	520x471x187 / 20.47x18.54x7.36
1354G BREEDING+STOCK CAGE	1820.00 / 282.10	200 / 7.87	598x380x200 / 23.54x14.96x7.87

COMPACT CAGE THAT FEATURES AN OPTIMIZED DESIGN BASED ON THE NEW GUIDELINES, TO ACHIEVE THE HIGHEST ANIMAL/CAGE DENSITY.

A VERSATILE CAGE TO HOUSE AN HIGHER NUMBER OF RATS FOR STOCK, AS WELL AS BREEDING PURPOSES, SHAPED FOR AN EASIER ACCESS TO ANIMALS.



1500 BREEDING+STOCK CAGE



1354G BREEDING+STOCK CAGE



RABBITS

DIFFERENT CAGE SIZE AVAILABLE:

- X-TYPE CAGE - FLOOR AREA 4264 CM²
- R-TYPE CAGE - FLOOR AREA 4670 CM²
- P-TYPE CAGE - FLOOR AREA 5456 CM²

EXTERNAL NESTING BOX AVAILABLE IN DIFFERENT FLOOR AREAS:

- 1200 CM²
- 1400 CM²







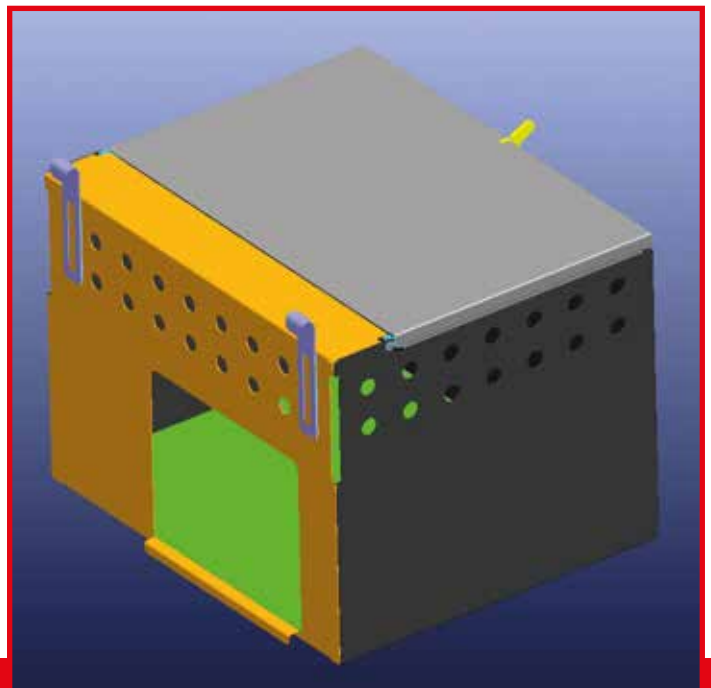
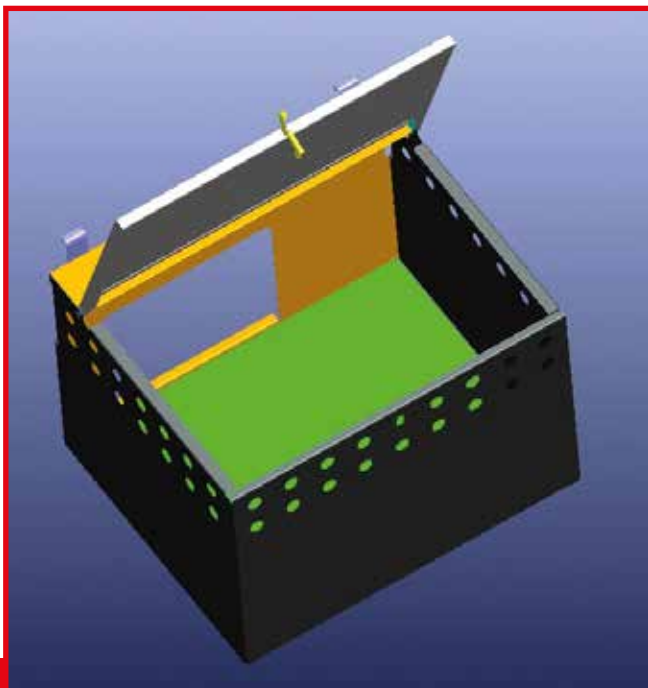

Guidelines assert that a nesting box is necessary to house a doe plus litter.

The Tecniplast external nesting box is compliant with guidelines and does not take up room from the cage surface. It is available in two different dimensions and it can fit all the rabbit racks types.

Racks were designed to achieve the best animal welfare and the lowest running costs. The injection molded Noryl cages assure a warm and comfortable environment for rabbits with no sharp edges and dirty traps, for easier and quicker washing procedures.



GUIDELINES







BREEDING	Species	Breeding Type	Min Enclosure Size			Min Enclosure Height		
								
			cm ²	cm ² /in ²	cm ²	cm	cm/in	cm
Mice	Pair/Trio inbred Trio Outbred		330	426/66	330	12	12.7/5	12
			510	523/81	510	12	12.7/5	12
Rats	Pair Trio		1200	1251/194	1300	18	17.8/7	18
			1600	1703/264	1700	18	17.8/7	18





MICE



RATS

STOCK AT BREEDERS	Species	Body Weight (g)	Min Enclosure Size		Floor Area/Animal		Min Enclosure Height	
								
			cm ²	cm ²	cm ²	cm ²	cm	cm
Mice	less than 20 less than 20		950	950	40	40	12	12
			1500	1500	30	30	12	12
Rats	up to 50			100	100			
	over 50 to 100	1500	1500	125	125	18	18	
	over 100 to 150 over 150 to 200			150	150			
Rats	up to 100			100	100			
	over 100 to 150	2500	2500	125	125	18	18	
	over 150 to 200			150	150			

Species	Body Weight (g)	Floor Area/Animal	Min Enclosure Height
			
		cm ² /in ²	cm/in
Mice	< 10	38.7/6	12.7/5
	up to 15	51.6/8	
	up to 25	77.4/12	
	> 25	≥96.7/15	
Rats	< 100	109.6/17	17.8/7
	up to 200	148.35/23	
	up to 300	187.05/29	
	up to 400	258/40	
	up to 500	387/60	
> 500	≥451.5/70		

	Body Weight (g)	Min Enclosure Size (cm ²)	Addition for Nest Boxes (cm ²)	Minimum Height (cm)
	less than 3	3500	1000	45
	from 3 to 5	4200	1200	45
	over 5	5400	1400	60



RABBITS

	Body Weight (g)	Min Total Floor Area with Nest Box (cm ²)*	Min Total Floor Area no Nest Box (cm ² **)	Minimum Height (cm)
	less than 3	4500	4000	45
	from 3 to 5	6400	6400	45
	over 5	6800	6400	60

* These measurements are to be used where a nest box is provided. If the nest box is outside the cage, the total floor area equals the floor area of the cage plus the floor area of the nest box. If the nest box is within the cage the total floor area equals the floor area of the cage. There are no minimum dimensions specified for nest boxes.

** These measurements to be used where there is no nest box provided

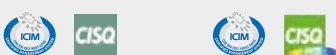

HEADQUARTERS
ITALY | Tel. +39 0332 809711 · www.tecniplast.it · E-mail: tecnicom@tecniplast.it; venditeitalia@tecniplast.it

SISTER COMPANIES

AUSTRALIA/NEW ZEALAND | Tel. + 61 2 8845 6500 · www.tecniplast.it · E-mail: info@tecniplast.com.au

CHINA | Tel. + 86 (0)21 50810920 · www.tecniplast.cn · E-mail: tecniplastchina@tecniplast.it

FRANCE | Tél. +33 (0)4 72 52 94 41 · www.tecniplast.fr · E-mail: info@tecniplast.fr

GERMANY | Tel. +49 (0)8805 921320 · www.tecniplast.de · E-mail: info@tecniplast.de

UNITED KINGDOM | Tel. + 44 (0)845 0504556 · www.tecniplast.it · E-mail: info@tecniplastuk.com

JAPAN | Tel. +81 (0)3 5770 5375 · www.tecniplast.it · E-mail: info@tecniplastjapan.co.jp

USA | Toll Free: +1 877.669.2243 · www.tecniplastusa.com · E-mail: info@tecniplastusa.com

CANADA | Toll Free: +1 855.347.8718 · www.tecniplastcanada.com · E-mail: info@tecniplastcanada.com

TO FIND YOUR LOCAL DISTRIBUTOR, PLEASE VISIT WWW.TECNIPLAST.IT